

ESSE





MASTER
STOVE
MAKER
SINCE 1854

MASTER
STOVE
MAKER
SINCE 1854

ESSE

ESSE: The warm heart of your home.

Heating trends have evolved since 1854, when the first ESSE stoves were sold, yet we still believe the deep, room-filling warmth of a stove remains the cosiest way to heat your home.

ESSE products maintain the look and feel of traditional stoves, but the technology and innovation that underpins these craftsmen-built products is very definitely 21st century.

Ever since 1854, ESSE has been at the forefront of solid fuel heating innovation. In the 19th and early 20th centuries, we established a worldwide reputation for producing the cleanest, most efficient and technologically advanced heating and cooking appliances available.

We have continued to evolve our stoves and maintain our commitment to energy efficiency and sustainability for the future.

Stoves such as the 500 surpass current and impending (2022) emissions regulations and looking even further ahead, ESSE is working with scientists from Manchester University to develop ever cleaner technologies.

In 2016, we led the market with the introduction of automatic ignition – an innovative way to light our stoves at the touch of a button without firelighters.

All ESSE stoves offer a clear, unimpeded view of the flames within and Afterburn™ technology keeps the glass clear while maximising energy efficiency.

When it comes to reducing our carbon footprint, sustainably sourced seasoned firewood is one of the most environmentally friendly fuels available, emitting minimal smoke and leaving only a tiny amount of ash.

We continue to innovate and lead the market with the introduction of versatile new products which reflect a commitment to the environment and high-quality British product design and performance.

An ESSE stove creates a focal point at the heart of the home filling the entire space with radiant, welcoming warmth and, we'd like to think, your heart with joy!

CONTENTS

| | |
|----|--------------|
| 4 | 175 |
| 5 | 105 |
| 6 | 155 |
| 7 | 500 |
| 8 | 100 / 200 |
| 9 | 100 / 200 DD |
| 10 | 700 |
| 11 | 150 / 250 |
| 12 | 550 |
| 13 | 125 / 225 |
| 14 | 525 |
| 15 | 301 / 350 |
| 16 | ESSE 1 |
| 17 | Ironheart |
| 18 | Options |
| 19 | Dimensions |

OVER 160 YEARS OF ENERGY-EFFICIENT STOVE DESIGN

1854

ESSE founder James Smith developed closed stoves for pioneers opening up the American Wild West and brought this design back to Britain and began producing ESSE stoves in the UK. The 'Bontesse' was the first British stove to use cleaner-burning anthracite.

1909

Shackleton and Scott relied on ESSE stoves during their expeditions across the frozen wastes of the Antarctic. The 'Pioneer' stove was a dedicated woodburner with secondary manifold to reburn smoke, offering exceptional performance and cleaner emissions.

1970

In response to the oil price shock, ESSE launched the large capacity Dragon stove with a wide body to take larger logs. The ornate design proved extremely popular.

2000

ESSE's stove collection continued to evolve and 'smoke exempt' wood-burning models became available for use in smoke control areas throughout the UK.

2004

The Ironheart was launched to celebrate ESSE's 150th anniversary. This iconic cookstove was chosen by Hugh Fearnley-Whittingstall for heating and cooking at River Cottage.

2016

Automatic Electric Ignition, the hot technology to light your fire, was introduced. It signalled an end to matches, firelighters and burnt fingers. Today Automatic Ignition is available on selected models.

2019

The latest generation of Ecodesign Ready wood-fired stoves surpass the strictest air quality emissions and efficiency standards without compromising on burn rate control and adjustability and are approved for use in smoke control zones.

2020

More Ecodesign Ready stoves are launched in advance of the 2022 environmental standard including ESSE 175 the cleanest wood-burning stove we've ever built. Check esse.com for the latest information as more ESSE stove models meet the Ecodesign criteria.



1854's ESSE 'Fame'

2021 ESSE 105

Since 1854 we have been creating stoves that burn cleanly and efficiently. ESSE stoves have been evolving for over 160 years, and we maintain the same ethos of fuel economy and energy efficiency to this day.





175 5kW

Clean in looks and clean in use are the principles behind ESSE 175 – the cleanest wood-burning stove we’ve ever built. 175 is available with classic feet or a stylish solid base. It offers the trademark ESSE wide fire view, clear glass, and a slim profile. Inside the 175 is our Particulate Reburn™ Technology, essentially the combination of a particle filter and a catalytic combustor, designed to give more heat and reduce emissions. A manual bypass control ensures easy lighting and easy refuelling.



175F



175B

| | |
|---|---|
| ENERGY RATED | A |
| EFFICIENCY | 83.7% |
| 175F |   |
| 175B | |
| NOMINAL HEAT OUTPUT | 5.0kW |
| FLUE PIPE DIAMETER | 5" (125mm) |
| APPROVED FOR USE ON DECORATIVE HEARTHES | YES |
| WEIGHT | 98kg |
| ADDITIONAL ROOM VENT | NO |
| CLEARANCES TO COMBUSTIBLES | 600mm sides, 600mm rear (400mm sides, 75mm rear with additional heat shield) |
| TOP AND REAR FLUE OPTIONS | YES |



105 5kW



Esse 105 has a more traditional look but with modern super clean catalytic performance. With all the visual presence of a larger stove ESSE 105 has the depth to sit neatly on a shallow hearth. The ESSE 105 incorporates Particulate Reburn™ Technology, essentially the combination of a particle filter and a catalytic combustor, to extract more heat from every log to maximise output with minimal emission. A manual bypass control ensures easy lighting and easy refuelling.

| | |
|---|---|
| ENERGY RATED | A |
| EFFICIENCY | 83.7% |
| 105 | |
|   | |
| NOMINAL HEAT OUTPUT | 5.0kW |
| FLUE PIPE DIAMETER | 5" (125mm) |
| APPROVED FOR USE ON DECORATIVE HEARTHES | YES |
| WEIGHT | 85kg |
| ADDITIONAL ROOM VENT | NO |
| CLEARANCES TO COMBUSTIBLES | 600mm sides, 600mm rear (400mm sides, 75mm rear with additional heat shield) |
| TOP AND REAR FLUE OPTIONS | YES |



155 5kW



Sharp in design and very 21st Century ESSE 155 reflects the 'clean in design and clean in use' principles of ESSE founder James Smith when he made his first ESSE stove back in 1854. The ESSE 155 uses our Particulate Reburn™ Technology, essentially the combination of a particle filter and a catalytic combustor, designed to give more heat and reduce emissions. A manual bypass control ensures easy lighting and easy refuelling.

| | |
|---|---|
| ENERGY RATED | A |
| EFFICIENCY | 83.7% |
| 155 | |
|   | |
| NOMINAL HEAT OUTPUT | 5.0kW |
| FLUE PIPE DIAMETER | 5" (125mm) |
| APPROVED FOR USE ON DECORATIVE HEARTHES | YES |
| WEIGHT | 82kg |
| ADDITIONAL ROOM VENT | NO |
| CLEARANCES TO COMBUSTIBLES | 600mm sides, 600mm rear (400mm sides, 75mm rear with additional heat shield) |
| TOP AND REAR FLUE OPTIONS | YES |



500 5kW

The ESSE 500 features our signature door styling and technologically advanced performance. Wide, clean glass offers an unrivalled fire view while an efficient fire box with tertiary air ensures great fuel economy. The 500 is constructed from a high quality steel with cast iron detail on the top, door and feet. The 500 is a simple-to-use 5kW multi-fuel stove, including twin position riddling grate with both wood and mineral fuel settings. For ease of installation, the 500 features a flue draft test point.

| | |
|---|-------------------------|
| ENERGY RATED | A+ |
| EFFICIENCY | 82.9% |
| 500 | |
|   | |
| NOMINAL HEAT OUTPUT | 5.0kW |
| FLUE PIPE DIAMETER | 5" (125mm) |
| APPROVED FOR USE ON DECORATIVE HEARTHES | YES |
| WEIGHT | 60kg |
| TERTIARY AIR | YES |
| CLEARANCES TO COMBUSTIBLES | 400mm sides, 400mm rear |
| AVAILABLE WITH LOG STORE | 220mm (H) |
| TOP AND REAR FLUE OPTIONS | YES |



100 / 200 5kW / 7.6kW

One design in two sizes, both ESSE 100 and 200 offer our trademark wide fire view, traditional arched door with clean glass, twin position grate for either wood or clean burning mineral fuel. ESSE 100 has a shallow depth for use on a slim hearth with a nominal 5kW output. ESSE 200 is a deeper stove with a nominal 7.6kW output for the larger room. Top and rear flue outlet options, flue draft test point, and levelling feet for sitting on a slightly uneven hearth are universal to both stove models.

| | 100 | 200 |
|----------------------------|-----------------------------|---|
| ENERGY RATED | A | A+ |
| EFFICIENCY | 82.1% | 81.1% |
| 100 | |  |
| 200 | | |
| NOMINAL HEAT OUTPUT | 5.0kW | 7.6kW |
| FLUE PIPE DIAMETER | 5" (125mm) | 5" (125mm) |
| APPROVED FOR USE | | |
| ON DECORATIVE HEARTH | YES | YES |
| WEIGHT | 84kg | 99kg |
| ADDITIONAL ROOM VENT | NO | (1925mm ² or Ø 50mm) |
| CLEARANCES TO COMBUSTIBLES | 100 600mm sides, 600mm rear | 200 400mm sides, 400mm rear |
| | | (200 150mm Rear with additional Heat Shield) |
| AVAILABLE WITH LOG STORE | 300mm (H) | 300mm (H) |
| TOP AND REAR FLUE OPTIONS | YES | YES |



100 / 200 5kW / 7.6kW Double Door

The popular ESSE 100 and 200 are both available with traditional double doors. These models are designed to be used with the doors closed, and with such clean glass and high performance, there is no reason to burn with doors open. The traditional look of a double door, however, will never go out of style. As with the 100 and 200, the double door models have adjustable feet allowing the stove to sit steady on an uneven hearth, the option of either top or rear flue, flue draft test point and simple air controls.

| | 100DD | 200DD |
|----------------------------|--|---------------------------------------|
| ENERGY RATED | A | A+ |
| EFFICIENCY | 82.1% | 81.1% |
| 100 DD | | Smoke control area approved |
| 200 DD | | |
| NOMINAL HEAT OUTPUT | 5.0kW | 7.6kW |
| FLUE PIPE DIAMETER | 5" (125mm) | 5" (125mm) |
| APPROVED FOR USE | | |
| ON DECORATIVE HEARTH | YES | YES |
| WEIGHT | 84kg | 99kg |
| ADDITIONAL ROOM VENT | NO | YES |
| CLEARANCES TO COMBUSTIBLES | 100 DD 600mm sides, 600mm rear 200 DD 400mm sides, 400mm rear <small>(200 DD 150mm Rear with additional Heat Shield)</small> | |
| AVAILABLE WITH LOG STORE | 300mm (H) | 300mm (H) |
| TOP AND REAR FLUE OPTIONS | YES | YES |



700 9kW

The mighty ESSE 700 is a multi-fuel stove with an impressive 9kW nominal heat output. Its majestic stature makes it ideal for large fireplaces. A twin position riddling grate makes the ESSE 700 ideal for burning either wood or an approved clean burning mineral fuel. Primary and secondary air controls provide simple yet total control. The 700 incorporates a rear 80mm diameter air inlet through which all combustion air is supplied.

| | |
|---|---|
| ENERGY RATED | A |
| EFFICIENCY | 78.0% |
| 700 |  |
| NOMINAL HEAT OUTPUT | 9kW |
| FLUE PIPE DIAMETER | 6" (150mm) |
| APPROVED FOR USE ON DECORATIVE HEARTHES | YES |
| WEIGHT | 102kg |
| ADDITIONAL ROOM VENT | (3025mm ² or Ø 62mm) |
| CLEARANCES TO COMBUSTIBLES | 400mm sides, 400mm rear, (250mm with additional heat shield) |
| AVAILABLE WITH LOG STORE | 300mm (H) |
| TOP AND REAR FLUE OPTIONS | YES |



150 / 250 5kW / 7.6kW

The ESSE 150 and 250 feature clean lines, long legs and an oversize clear glass window offering an enticing view of the natural flames dancing within.

The 150 and 250 have ESSE's signature clean burn technology which enables these models to be fired in smoke exempt zones throughout the UK.

The 150 and 250 are economical to run and incorporate both primary and secondary air controls for precision adjustment of the burn rate and the ability to create some beautiful flame patterns.



| | 150 | 250 |
|----------------------------|--|-----------------------------|
| ENERGY RATED | A | A+ |
| EFFICIENCY | 82.1% | 81.1% |
| 150 | | Smoke control area |
| 250 | | approved |
| NOMINAL HEAT OUTPUT | 5.0kW | 7.6kW |
| FLUE PIPE DIAMETER | 5" (125mm) | 5" (125mm) |
| APPROVED FOR USE | | |
| ON DECORATIVE HEARTHES | YES | YES |
| WEIGHT | 84kg | 99kg |
| ADDITIONAL ROOM VENT | NO | YES Ø50MM |
| CLEARANCES TO COMBUSTIBLES | 150 600mm sides, 600mm rear | 250 400mm sides, 400mm rear |
| | (250 150mm Rear with additional Heat Shield) | |
| TOP AND REAR FLUE OPTIONS | YES | YES |



550 5kW

Tall and handsome the ESSE 550 is built around a proven and super-efficient ESSE firebox design.

Ideal as a focal point in a modern open-plan space or the centrepiece of a cosy lounge, the 550 has an energy rating of 'A+', and a clean burning design which enables it to be fired in smoke exempt zones throughout the UK. A twin position grate allows for both wood and clean burning approved mineral fuel to be used.

| | |
|---|-------------------------|
| ENERGY RATED | A+ |
| EFFICIENCY | 82.9% |
| 550 | |
|   | |
| NOMINAL HEAT OUTPUT | 5.0kW |
| FLUE PIPE DIAMETER | 5" (125mm) |
| APPROVED FOR USE ON DECORATIVE HEARTHES | YES |
| WEIGHT | 51kg |
| ADDITIONAL ROOM VENT | NO |
| CLEARANCES TO COMBUSTIBLES | 400mm sides, 450mm rear |
| TOP AND REAR FLUE OPTIONS | YES |



125 / 225 5kW / 7.6kW

The ESSE 125 and 225 have all the benefits of the ESSE 100 and 200 but with a contemporary twist. This design offers impressive efficiency levels of over 80% and comforting nominal heat outputs of 5 and 7.6kW respectively.

The 125 and 225 are steel bodied with cast door and stainless steel pillars. An optional 'all black' finish is available.

ESSE 125 and 225 have a twin position grate which is ideal for burning both wood and clean burning approved mineral fuel. Simple top and bottom air controls make for easy and efficient operation.



Optional Black pillars

| | 125 | 225 |
|----------------------------|-----------------------------|--|
| ENERGY RATED | A | A+ |
| EFFICIENCY | 82.1% | 81.1% |
| 125 | | Smoke control area approved |
| 225 | | |
| NOMINAL HEAT OUTPUT | 5.0kW | 7.6kW |
| FLUE PIPE DIAMETER | 5" (125mm) | 5" (125mm) |
| APPROVED FOR USE | | |
| ON DECORATIVE HEARTHES | YES | YES |
| WEIGHT | 84kg | 99kg |
| ADDITIONAL ROOM VENT | NO | YES |
| CLEARANCES TO COMBUSTIBLES | 125 600mm sides, 450mm rear | 225 400mm sides, 450 mm rear (225 150mm Rear with additional Heat Shield) |
| TOP AND REAR FLUE OPTIONS | YES | YES |





525 5kW

A contemporary stove with a 5kW nominal heat output, ESSE 525 is ideally suited to sit in a fireplace chamber or builders opening. The spectacular and uncluttered view of the flames is elegantly framed by stainless steel columns and can be easily controlled by beautifully engineered air controls. Its small footprint and moderate output make it easy to plan into a modern living space without overpowering a centrally heated room. A twin position grate allows for both wood and clean burning approved mineral fuel.



Optional Stainless Steel pillars

| | |
|---|-------------------------|
| ENERGY RATED | A+ |
| EFFICIENCY | 82.9% |
| 525 | |
|   | |
| NOMINAL HEAT OUTPUT | 5.0kW |
| FLUE PIPE DIAMETER | 5" (125mm) |
| APPROVED FOR USE ON DECORATIVE HEARTHES | YES |
| WEIGHT | 80kg |
| ADDITIONAL ROOM VENT | NO |
| CLEARANCES TO COMBUSTIBLES | 400mm sides, 400mm rear |
| TOP AND REAR FLUE OPTIONS | YES |



301/350 4kW / 5kW

Onset stoves offer a very efficient way to heat your room; the firebox sits inside a second outer casing with a cavity between the two. Cool air from the room is drawn in at the base of the stove and heated before rising out of the top into the room. The 301 fits straight into a standard fireplace. The 350 also fits into a standard fireplace, however, the brick fire back needs to be removed to accommodate the larger firebox. Unlike 'non-convection stoves' - which radiate heat in straight lines - ESSE inset convector stoves both radiate heat and produce a gentle stream of warming air.

| | 301 | 350 |
|----------------------------|---|------------|
| ENERGY RATED | A+ | A |
| EFFICIENCY | 82.9% | 79.7% |
| 301 |  | |
| 350 | | |
| NOMINAL HEAT OUTPUT | 4.0kW | 5.0kW |
| FLUE PIPE DIAMETER | 6" (150mm) | 6" (150mm) |
| WEIGHT | 59kg | 69kg |
| CLEARANCES TO COMBUSTIBLES | 150mm sides, 400mm top, 250mm front | |





ESSE 1 5kW

A According to Aesop, ‘good things come in small packages’. This adage is certainly true when it comes to the ESSE 1. It is far from basic and as you would expect from an ESSE it is packed with small details including flue draft test point, levelling adjustment so it can sit on a slightly uneven hearth and it is Ecodesign ready.

There is even a multi-fuel version for all who desire the capability of burning an approved clean burning mineral fuel.



With Log Store

| | |
|----------------------------|---|
| ENERGY RATED | A+ |
| EFFICIENCY | 81.9% |
| ESSE 1 |   |
| NOMINAL HEAT OUTPUT | 5.0kW |
| FLUE PIPE DIAMETER | 5" (125mm) |
| WEIGHT | 56 kg |
| CLEARANCES TO COMBUSTIBLES | 500mm sides 700mm rear |
| TOP AND REAR FLUE OPTIONS | YES |



IRONHEART EW/EWB/ECO

9.7kW(EW) / 10.5kW(EWB) / 7.6kW(ECO)

The Ironheart was created to mark 150 years of ESSE. It combines the quintessential features of a superb wood-burning stove and traditional range cooker, celebrating all that ESSE does best. Use it to cook a full roast in the oven - with six pans on the hotplate - or simply to boil the whistling kettle. Toast in the firebox or prove dough around the Ironheart's warm edges for baking fresh, crusty loaves.

Ironheart is available as an Ecodesign wood-burning model or in dry and wet non-Ecodesign multi-fuel models. Meanwhile Bakeheart and Warmheart complete the ESSE Ironheart cook stove family.

Also available in the Ironheart family are



**ECODESIGN
READY**

Smoke control area
approved

| | IRONHEART | BAKEHEART / WARMHEART |
|---|---|--|
| ENERGY RATED | A | A |
| EFFICIENCY | 81.8% 80.6% (ECO) | 77% |
| NOMINAL HEAT OUTPUT | 9.7KW (EW) 10.5KW (EWB) 7.6KW (ECO) | 5kW |
| FLUE PIPE DIAMETER | 6" (150mm) | 6" (150mm) |
| APPROVED FOR USE ON DECORATIVE HEARTHES | YES | YES |
| WEIGHT | 280KG | 195kg / 120kg |
| ADDITIONAL ROOM VENT KIT | YES | OPTIONAL EXTERNAL AIR |
| CLEARANCES TO COMBUSTIBLES (Sides / Rear) | EW 300mm / 500mm EWB 200mm / 400mm | BAKEHEART 400mm / 500mm WARMHEART 350mm sides / 400mm |

LOG STORE

Our log store is available for the ESSE 1, ESSE 100, 200, 500 and 700 models.

Log store enables you to neatly keep your fuel close at hand. It can be purchased with your stove or supplied as a retro fit.

The table below details which stoves are compatible with which log store.

| | 220mm | 300mm |
|--------|-------|-------|
| ESSE 1 | | x |
| 500 | x | |
| 100 | x | x |
| 200 | | x |
| 700 | | x |



AUTOMATIC ELECTRIC IGNITION

Hot technology. ESSE wood-burning stoves are the first in the world to use the automatic electric ignition system in the home.

The combustion unit ignites the fire inside a wood-burning stove with the touch of a button. It means an end to matches, firelighters and burnt fingers.

The ingenious British-invented electronic ignition system is simple to use – load your dry logs in front of the air jet, close the door, press the remote control and the lighting cycle begins.

When your wood logs ignite the flue is already preheated to a working temperature to ensure cleaner burning and improved control.

| | |
|-----------------------|-------------------------|
| AVAILABLE ON | 100, 125 and 150 STOVES |
| HEATER ELEMENT OUTPUT | 2.1kW |
| LIGHTING CYCLE | 5-8 MINUTES |
| ELECTRICAL SUPPLY | 13AMP |



STEP BY STEP

- 1** The user initiates the lighting sequence by pressing the start button.
- 2** The rear vent opens.
- 3** The fan starts.
- 4** The heater element starts and hot air is blown onto the fuel. This lights and establishes the fire.
- 5** After five minutes, the heater element switches off.
- 6** The fan runs on for another 20 seconds before switching off.
- 7** The rear vent automatically closes.
- 8** Just sit back and enjoy your ESSE, while occasionally reloading with dry logs.

DIMENSIONS

105/100/DD / 200/200 DD

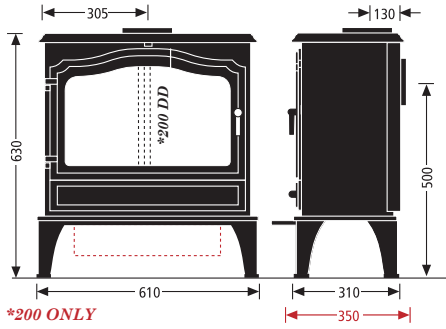

***200 ONLY**

WITH LOG STORE

100 Stove with 220mm Log Store - total height: 715mm
 100 Stove with 300mm Log Store - total height: 795mm
 200 Stove with 300mm Log Store - total height: 795mm

500

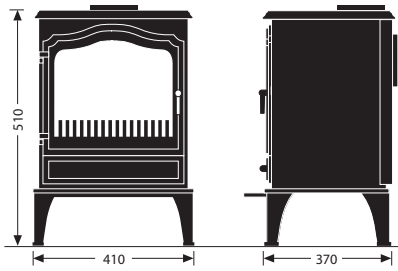

Distance from centre of flue to back of stove 145mm.
 Distance from hearth to centre of flue 390mm.

WITH LOG STORE

500 Stove with 220mm
 Log Store - total height: 675mm

700

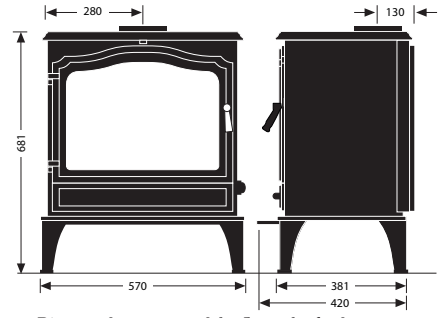

Distance from centre of the flue to back of stove 114mm
 Distance from hearth to centre of flue 561mm

WITH LOG STORE

700 Stove with 300mm
 Log Store - total height: 832mm

125/225

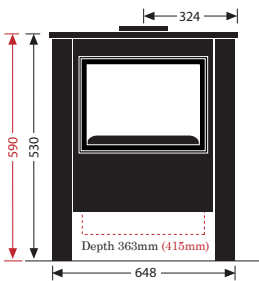

Distance from centre of flue to back of stove 145mm (135mm). Distance from hearth to centre of flue 405mm (453mm). ***225 ONLY**

525/525

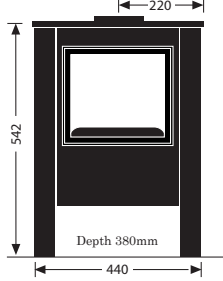

Distance from centre of flue to back of stove 140mm.
 Distance from hearth to centre of flue 415mm (585).

155/150/250

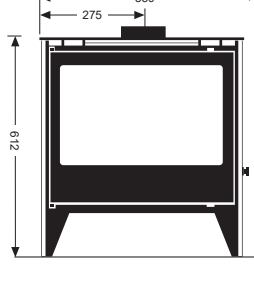

Distance from centre of the flue to back of stove 115mm
 Distance from hearth to centre of flue 460mm

Depth: 250mm
Depth: 345mm (250 ONLY)

550/550

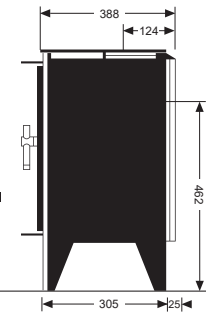
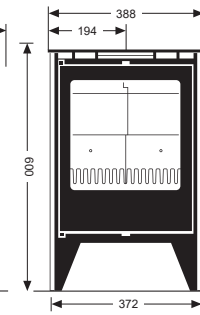

ESSE I

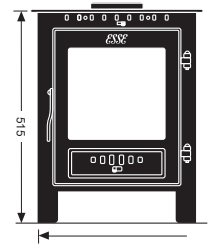

Distance from centre of the flue to back of stove 141mm
 Distance from hearth to centre of flue 400mm
Depth: 370mm

301/350

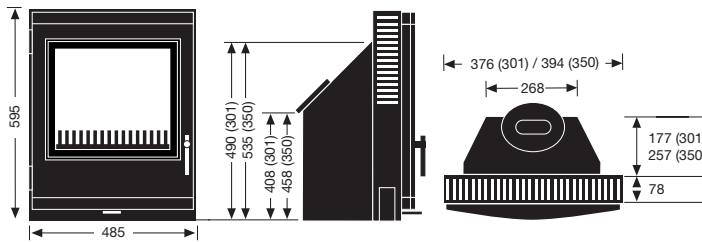

A round flue adaptor is available to allow connection to a flue pipe or flexible chimney liner. This can be connected to the liner and then fitted from inside the stove.

- A) Between 396 & 420mm.
- B) Between 540 & 560mm.
- C) Extending 50mm around opening.
- D) Hearth at least 400mm deep without obstructions that could prevent the door from opening.

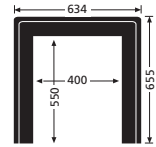

Optional inset steel fitting frame

REAR FLUE BOX

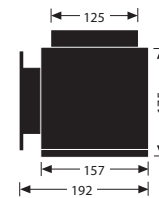

Rear flue box kits are available for most ESSE stoves. (Ironheart and 700 are top flue outlet only)

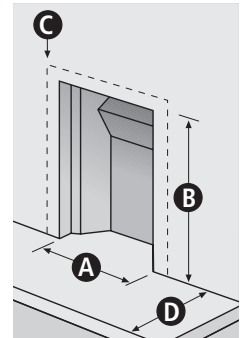

Fireplace dimensions for ALL models

175F/B

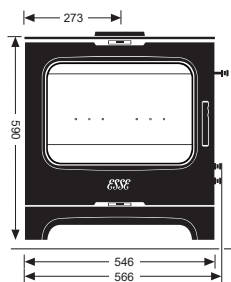

Depth: 325mm

Distance from centre of the flue to back of stove 115mm
 Distance from hearth to centre of flue 460mm

WARMHEART

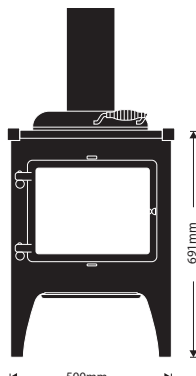

Depth: 600mm

BAKEHEART

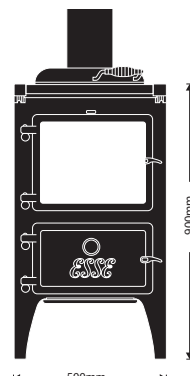

Depth: 600mm

IRONHEART

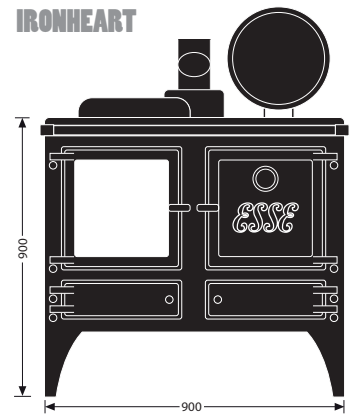

Depth 600mm

Depth: 600mm



ESSE Product Guarantee
Excluding consumables.
Subject to terms and conditions.
Visit esse.com for further information.

ESSE

Contact us

Got a question for us here at ESSE?
Please do get in touch.

enquiries@esse.com
esse.com



'ESSE' is a trademark of ESSE Engineering Limited ©2020.
All rights reserved. Please do not reproduce any part of
this publication without permission from ESSE Engineering
Limited. First published 1854. This edition March 2021.