

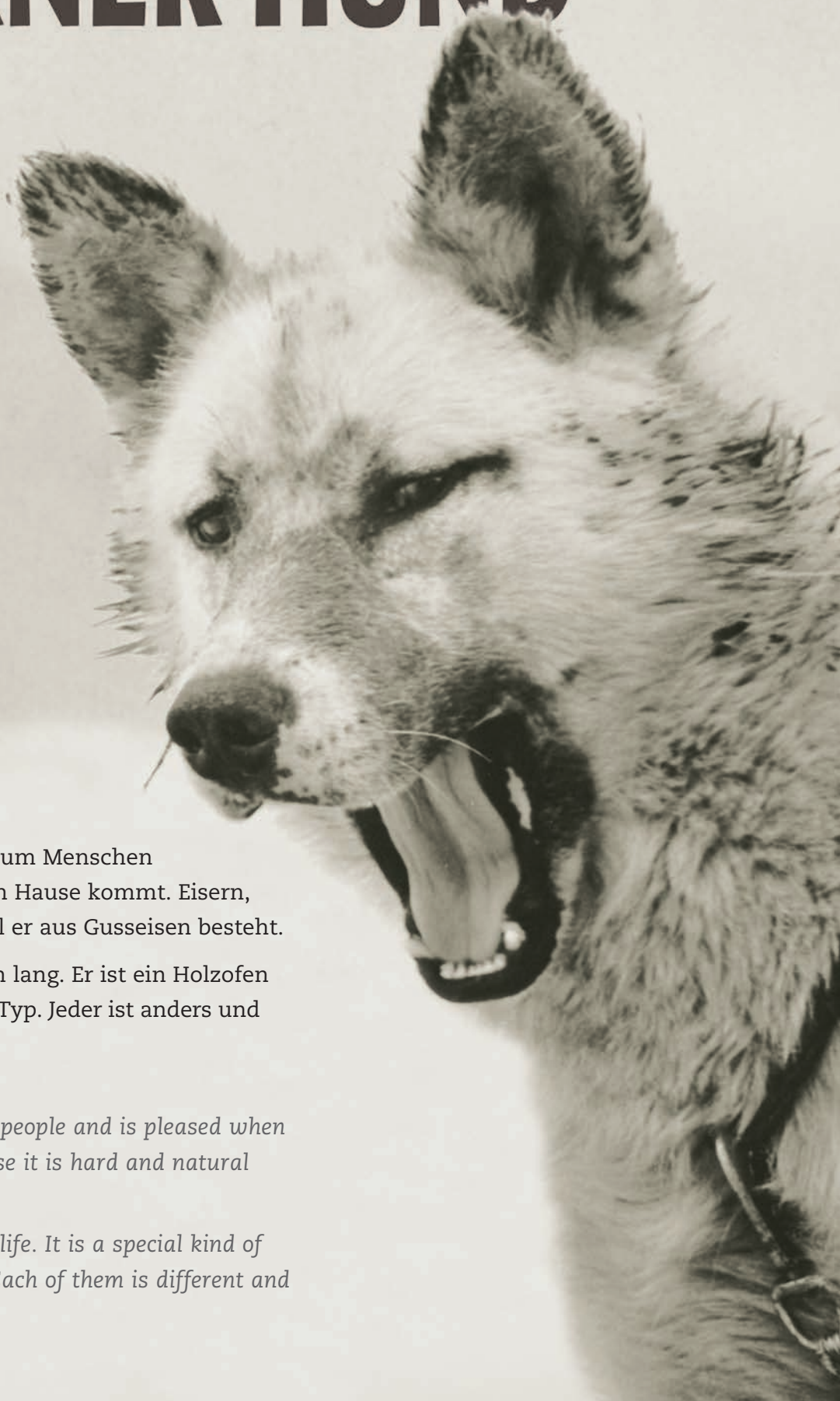

IRON DOG[®]

EISERNER HUND[®]



Ein Hund ist treu, liebt die Nähe zum Menschen und freut sich, wenn jemand nach Hause kommt. Eisern, weil er hart ist und natürlich, weil er aus Gusseisen besteht.

Der »Eiserne Hund« hält ein Leben lang. Er ist ein Holzofen der besonderen Art. Finde deinen Typ. Jeder ist anders und einzigartig. Er wird dein Freund.

A dog is loyal, loves being close to people and is pleased when someone returns home. Iron because it is hard and natural because it is made of cast iron.

The »Iron Dog« stays with you for life. It is a special kind of wood-fired stove. Find your type. Each of them is different and unique. He will be your friend.

EISERNE HUNDE

sind Gussöfen made in Germany. Hergestellt von einem Familienbetrieb in der 3. Generation, der bis heute nur Holzöfen gebaut hat. In dieser Serie steckt all das Können und Wissen für einen außergewöhnlichen Ofen in außergewöhnlicher Qualität. Deshalb auch der außergewöhnliche Name »Eiserner Hund«.

Für außergewöhnliche Menschen oder als Geschenk an Freunde.

IRON DOGS

are cast iron stoves made in germany. They are manufactured by the 3rd generation of a family-owned company which has only manufactured wood-fired stoves right up to today.

This production comprises all of the skills and knowledge which is required for an extraordinary stove of an extraordinary quality. This is why they also have the extraordinary name »Iron Dog«.

For extraordinary people or as a gift for friends.



IRON DOG®

Das Lastenheft. *The specifications.*

Produkt: <i>product:</i>	Kaminofen <i>chimney stove</i>
Brennstoff: <i>fuel:</i>	Holz <i>wood</i>
Design: <i>design:</i>	Gestaltung mit Designern und Künstlern <i>designed by designers und artists</i>
Name: <i>name:</i>	aussagekräftig, einzigartig, international <i>meaningful, unique, international</i>
Material: <i>material:</i>	Gusseisen, 7 mm <i>cast iron, 7 mm</i>
Konstruktion: <i>construction:</i>	dichte Verschraubung, Verbindungstechnik edelstahl <i>tightly screwed connections, stainless steel thread</i>
Besonderheit: <i>special feature:</i>	gute Form, einfache Bedienung, geringe Emission <i>good form, easy to use, low emission</i>
Produktionsort: <i>place of production:</i>	Deutschland <i>germany</i>
Zielgruppe: <i>target group:</i>	Menschen mit Anspruch auf Form und Qualität <i>people who demand form and quality</i>

Der Name »Eiserner Hund« - »Iron Dog« - ist als Marke eingetragen und geschützt.

The name »Eiserner Hund« - »Iron Dog« - is registered and protected as a trademark.

Zahlbar & Preiswert. *affordable & inexpensive*

Ein Holzofen muss bezahlbar sein.
Die Qualität spürbar.

*A wood-fired stove must be affordable.
The quality noticeable.*

Design: design.mattis, Darmstadt
Giesserei: Ortrander Eisenhütte
mit Präzisionsmaschinen bearbeitet
von Menschenhand montiert
26 Gussteile
3 Stahlwellen
65 Edelstahlschrauben
1 Glaskeramik

*Design: design.mattis, darmstadt
Foundry: ortrander eisenhütte
Manufactured using precision machines
assembled by humans
26 cast parts
3 steel shafts
65 stainless steel screws
1 glass ceramic*

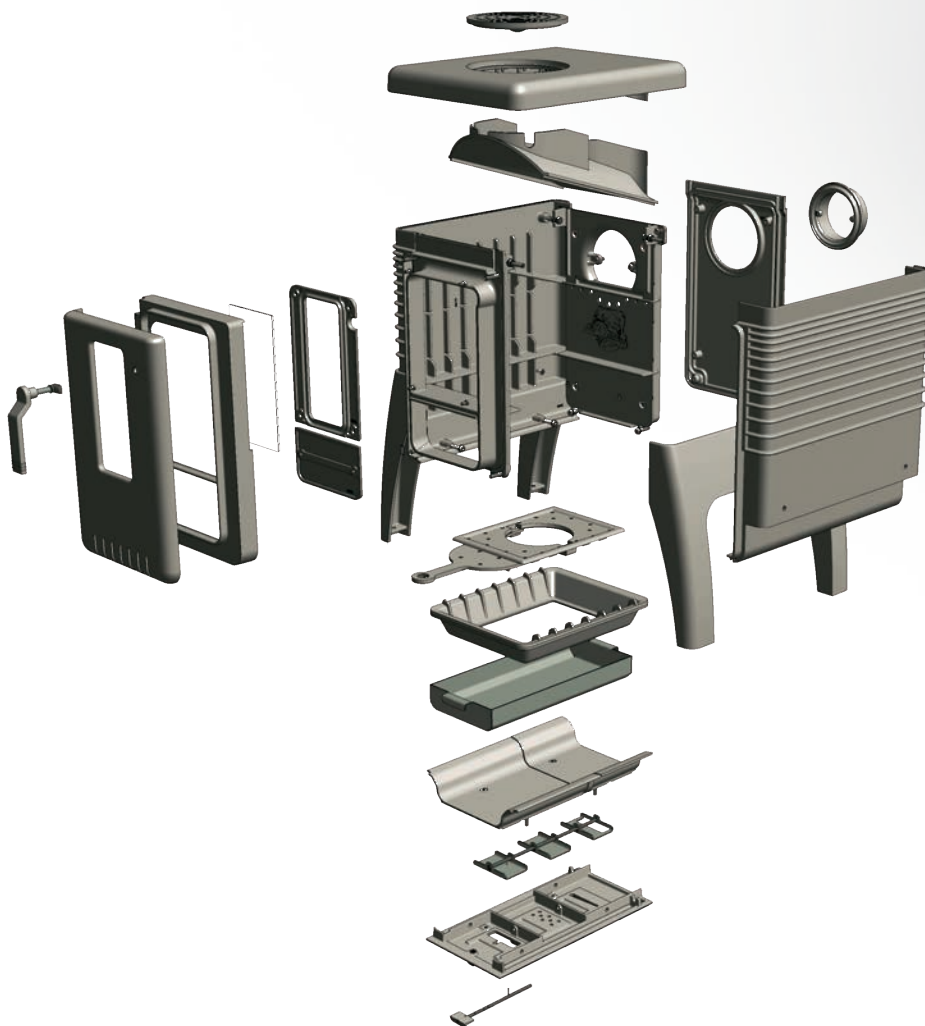

Iron Dog 02



Iron Dog 01

IRON DOG® N° 01

Ist alles im Leben technisch
abzusichern?

Wärme ist ein Grundbedürfnis.
Wer einen Holzofen besitzt, kann Kälte
besiegen - mit einfachsten Mitteln.

*Can everything in life be secured
by technical means?*

*Warmth is a basic need.
A person who owns a wood-fired stove
can conquer the cold - with the simplest
means.*

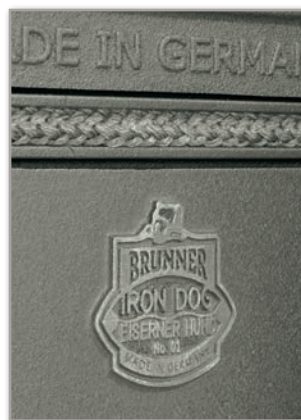

Fichte spruce





A

IRON DOG[®]

N° 02

Sind Gefühle wichtig?

Gefühle entscheiden alles.
Über Menschen, Situationen oder Produkte.

Are feelings important?

*Feelings decide everything.
About people, situations or products.*

10 | 11



Ahorn maple



A

IRON DOG® N° 03

Kann ein Holzofen ein guter
Freund sein?

Vertrautheit, Erinnerungen, schöne
Momente vor dem wärmenden Feuer
sind etwas Besonderes.

*Can a wood-fired stove be
a good friend?*

*Familiarity, memories, beautiful moments
in front of the warming fire are some-
thing special.*

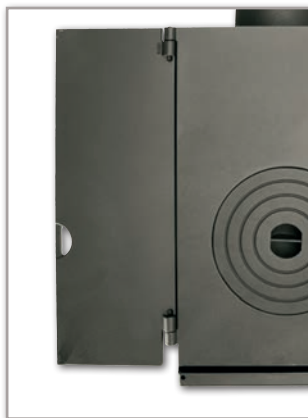

Esche ash



A

IRON DOG® N° 04

Können ein paar Holzscheite und
ein bequemer Sessel glücklich machen?

Zeit, Muse und Wohlbefinden sind durch nichts zu
ersetzen.

*Can a few logs and a comfortable armchair
make someone happy?*

*Time, muse and well-being cannot be replaced by
anything.*

14 | 15



Buche beech



A

IRON DOG[®] N° 05

Kunst und Wärme -
passt das zusammen?

Nichts ist so frei wie die Kunst
und die Menschen, die sie lieben.

*Art and warmth -
do they match?*

*Nothing is as free as art
and the people who love it.*

huraxdax



Eiche oak



huraxdax • Aufbruch zur Freude • decampent to joy • il piacere spicca il volo • la via del benessere • ИСТОЧНИК
РАДОСТИ une explosion de joie • het zonnetje in huis • uppbrott till glädje • skaper velvære og trivsel • olkaamme iloisia
wybuch radości • Začátek radostných chvíl • Ξεκινάμε Υία Χαρά • huraxdax



A

IRON DOG[®] N° 06

*Lebensfreude oder
Männerspielzeug?*

Wärme und ein zufriedener Bauch.
Was immer es sein soll.

Life's joy or man's toy?

Warmth and a satisfied belly.
Whatever it should be.

Kochmaschine *cooking machine*



Ahorn maple



A+

IRON DOG[®] N° 07

Darf ein Holzofen so
zeitlos schlicht sein?

Reduktion ist die Kunst
der Gestaltung.

*Can a wood stove be
so simple and timeless?*

Reduced design is a form of art.

20 | 21



Birke birch



A+

IRON DOG[®] N° 01

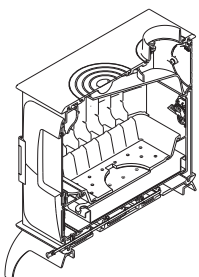
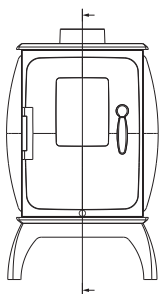
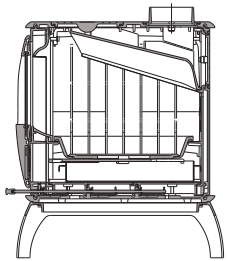
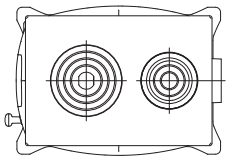
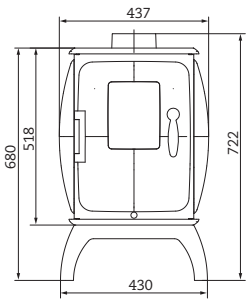
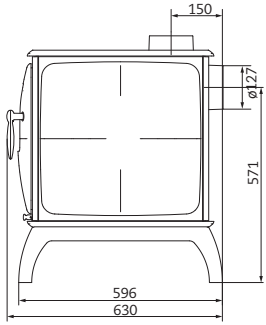

IRON DOG[®] N° 02

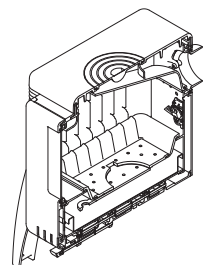
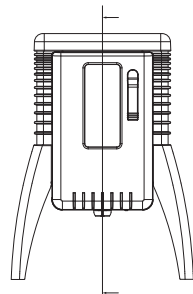
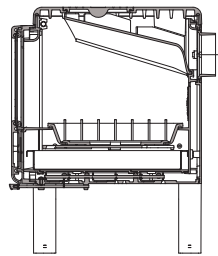
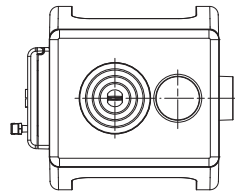
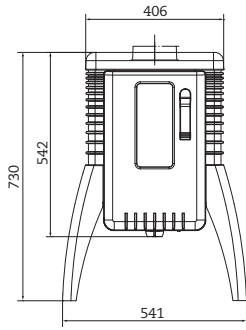
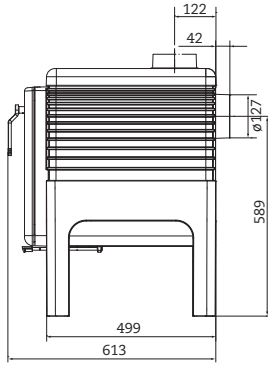

IRON DOG[®] N° 03

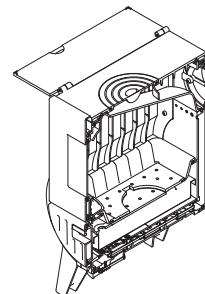
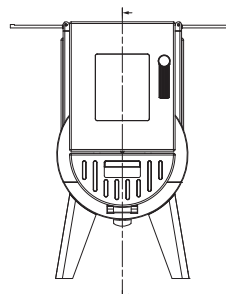
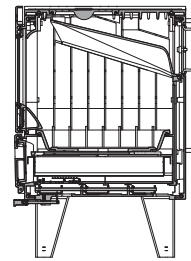
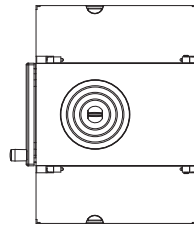
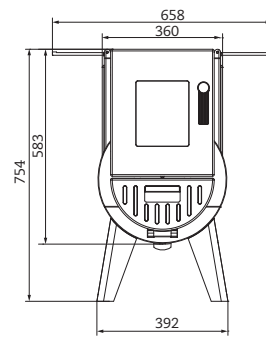
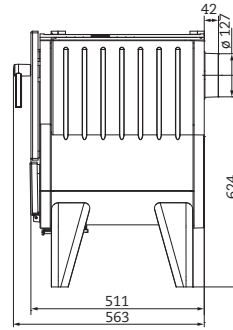

IRON DOG[®] N° 04

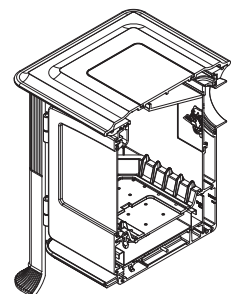
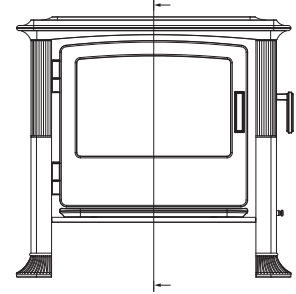
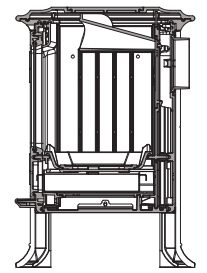
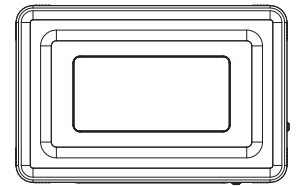
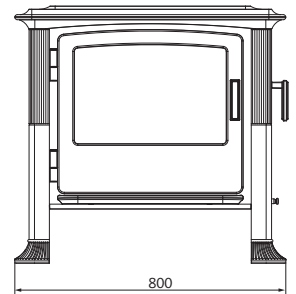
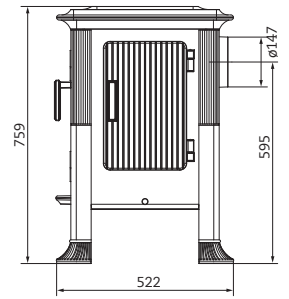

IRON DOG[®] N° 05

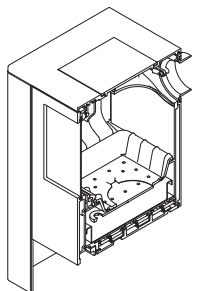
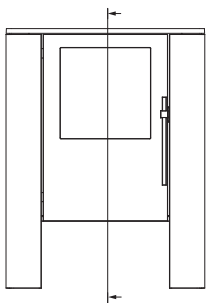
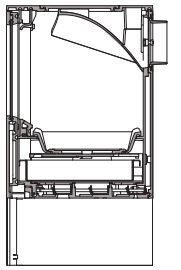
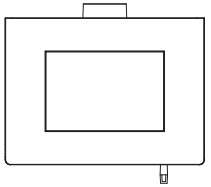
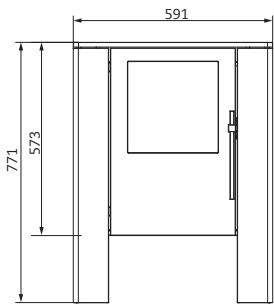
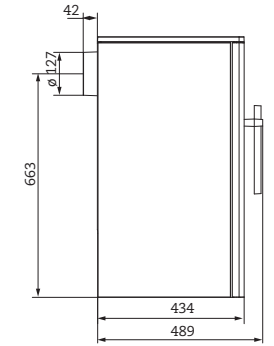

IRON DOG[®] N° 06

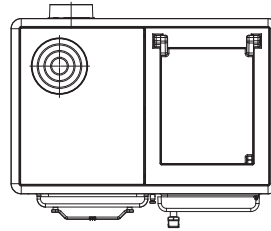
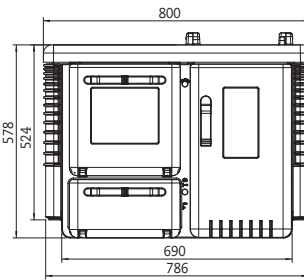
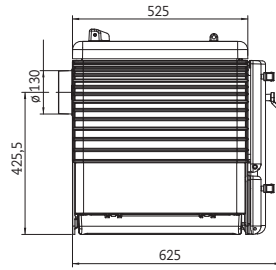
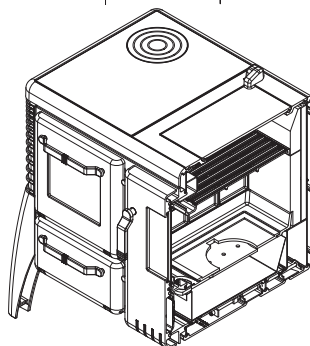
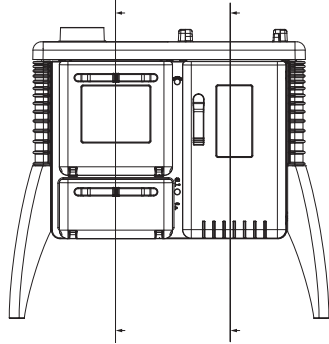
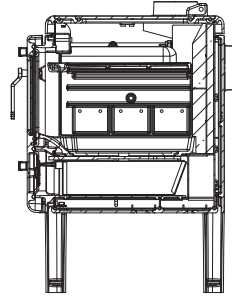
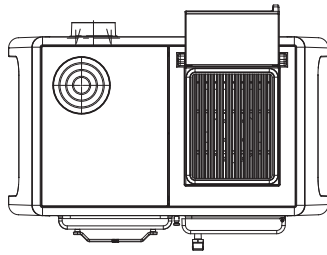
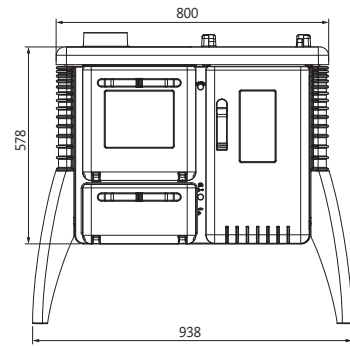
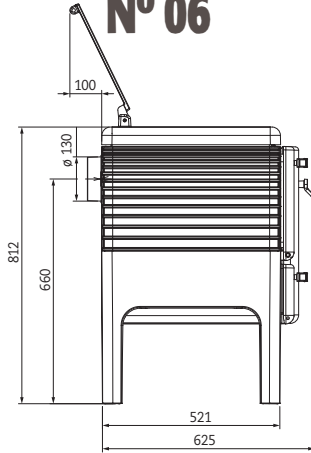

IRON DOG[®] N° 07

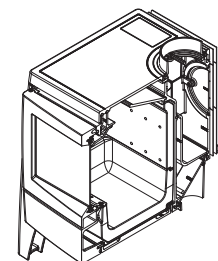
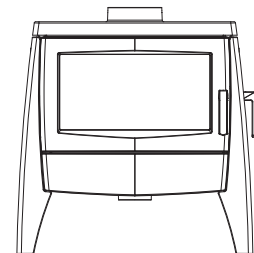
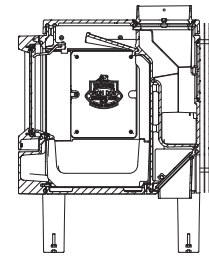
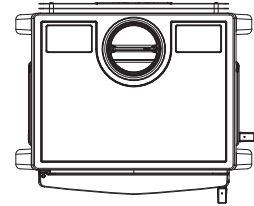
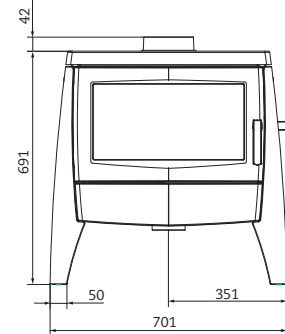
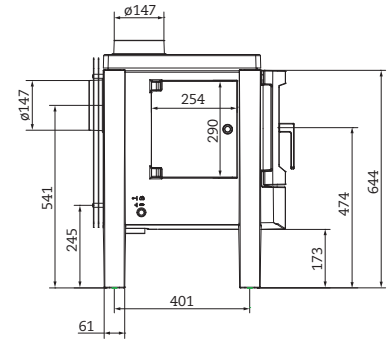

Zubehör:
Gussbräter, emailliert
accessory:
casserole, enamelled

Innenmaße:
internal dimensios:
360 x 285 mm

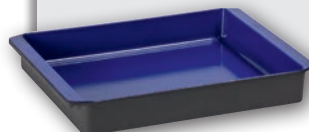

Technik. technology.

Eine ausgeklügelte Verbrennungsluftzuführung sorgt für eine langsame und gleichmässige Entgasung der Holzscheite bei geringsten Emissionen bzw. Verbrennungsrückständen. Die Primärluft ① strömt direkt in die Glutwanne und treibt sanft die Entgasung an. Die Sekundärluft ② hält die Glasscheibe sauber und durchmischt die Brenngase mit dem notwendigen Sauerstoff vor dem Flammkanal ③. Mit der Tertiärluft ④ werden die im hinteren Bereich des Feuerraumes austretenden Gase zeitnah durchmischt und zur Zündreaktion gebracht.

Die Bedienung erfolgt mit einem einzigen Stellelement ⑤. Einfacher kann ein Holzofen nicht bedient werden.

Der hohe Wirkungsgrad wird durch große Wärmeaufnahme­flächen in Kombination mit besonderen Heizgasumlenkungen erreicht.

A cleverly devised combustion air feed ensures a slow and constant degassing of the logs with the lowest possible emission and combustion residue respectively. The primary air ① flows direct into the embers pan and softly impels the degassing. The secondary air ② keeps the glass plate clean and thoroughly mixes the combustion gases with the required oxygen in front of the flame tube ③. The tertiary air ④ promptly mixes the gases which are emitted at the rear part of the combustion chamber and these are then ignited.

The operation takes place with a single adjusting element ⑤. There is no easier way to use a wood-fired stove.

The high degree of efficiency is achieved by means of large heat absorption surfaces in combination with special heating gas deflections.

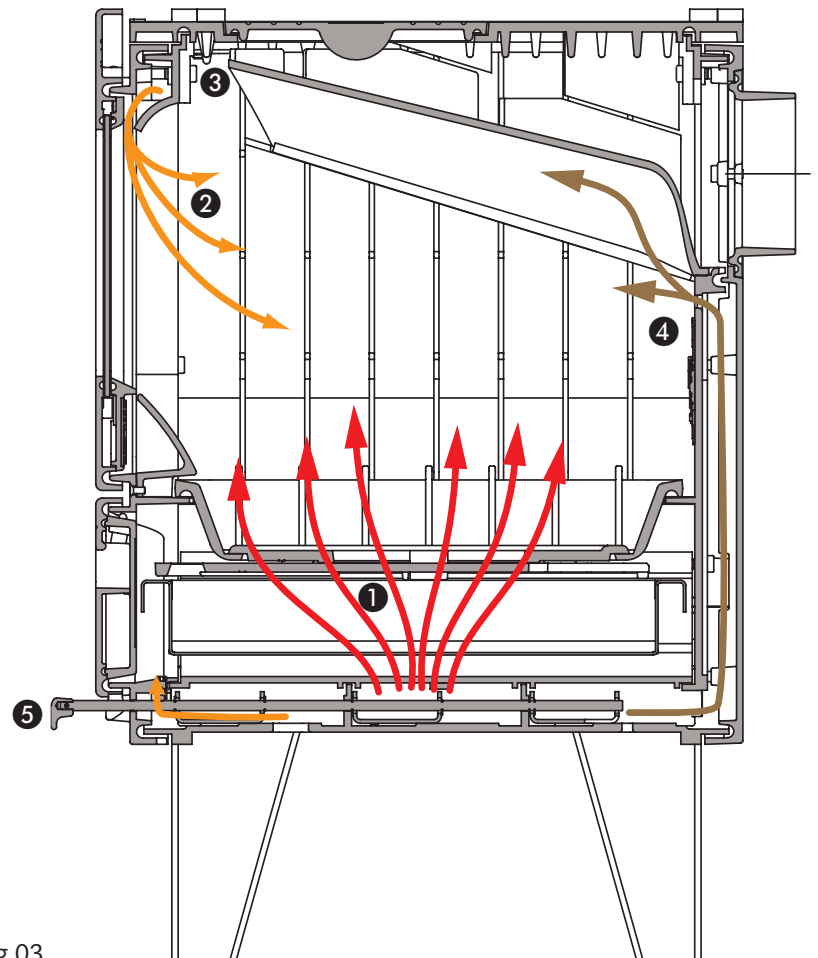

Iron Dog 03



Iron Dog 05

Wir machen alles selbst. Everything is our own work.

Das klingt zwar etwas altmodisch und deutsch, hat sich aber bewährt.

Nur wenn man das Ganze kennt, hängt Seele und Stolz aller Mitarbeiter an einem Produkt. Und das spürt man.

Das beginnt mit der Konstruktion mit eigenen Ingenieuren und Technikern, geht weiter mit einem Prototyp im Prüflabor und der Fertigung in unserer eigenen Gießerei..

Montage und Kontrolle sind die letzten Handgriffe, bevor ein IRON DOG in die Kiste kommt.

Und gibt es einmal etwas zu verbessern, so machen wir das sofort und gerne. Schließlich ist es unser Produkt.

It might sound a little old-fashioned but it is proven and tested.

Only when everyone knows everything, does the soul and pride of all of our employees hang on a product, and one notices it.

It starts with the design which is carried out by our own engineers and technicians, continues with the prototype in the test laboratory, followed by our own foundry.

Work, assembly and inspection and the last finishing touches before an IRON DOG is packed.

If anything should have to be improved, we do so immediately and like doing it. It is our product after all.



Ulrich Brunner



Hubertus Brunner



Technische Daten. Technical data.

Nennheizleistung <i>nominal heat output</i>	kW
--	----

Verbrauch/h <i>consumption/h</i>	kg
-------------------------------------	----

Raumheizvermögen <i>space heating capacity</i>	m ²
---	----------------

Energielabel / EEI <i>energy label / EEI</i>	
---	--

Gerätedaten *appliance data*

Maße (h x b x t) <i>dimensions (h x w x d)</i>	mm
---	----

Scheibenfläche (h x b) <i>glass pane surface</i>	mm
---	----

Feuerraumöffnung (h x b) <i>combustion chamber opening</i>	mm
---	----

Grillrostfläche <i>hot plate</i>	mm
-------------------------------------	----

Bratrohr (h x b x t) <i>baking oven</i>	mm
--	----

Rauchrohranschluß <i>flue outlet</i>	
---	--

Rauchrohrdurchmesser <i>flue diameter</i>	mm
--	----

Zulässige Brennstoffmenge <i>permitted fuel quantity</i>	kg
---	----

Feuerraumtiefe <i>combustion chamber dept</i>	cm
--	----

Empfohlene Scheitlänge <i>recommended log length</i>	cm
---	----

Gewicht Gusseisen <i>cast iron weight</i>	kg
--	----

Luftmengen *air quantities*

Verbrennungsluftbedarf <i>combustion air consumption</i>	m ³ /h
---	-------------------

Verbrennungsluftanschluss Durchmesser ¹⁾ <i>combustion air diameter ¹⁾</i>	mm
---	----

Mindestabstände *required minimum clearances*

zur Seitenwand <i>to the side wall</i>	cm
---	----

zur Rückwand (ohne strahlungsblech) <i>to the rear wall (without insulation panel)</i>	cm
---	----

zur Rückwand (mit ofenstrahlungsblech) <i>to the rear wall (with insulation panel stove)</i>	cm
---	----

zur Rückwand (mit ofen- & wandstrahlungsblech) <i>to the rear wall (with insulation panel stove & wall)</i>	cm
--	----

nach vorn <i>to the front</i>	cm
----------------------------------	----

Zulassungen *approvals*

¹⁾ Luftanschlusskasten erforderlich (Zubehör)
air connection box necessary (accessory)

Iron Dog 01	Iron Dog 02	Iron Dog 03	Iron Dog 04	Iron Dog 05	Iron Dog 06	Iron Dog 07
7	7	7	8	7	8	7
2	2	2	2,2	2	2,5	2,2
50 - 90	50 - 90	50 - 90	60 - 110	50 - 90	60 - 110	50 - 90
A / 106	A / 106	A / 106	A+ / 107,5	A / 106	A+ /108,9	A+ /108,9
680x440x630	730x540x610	760x390x560	760x800x520	770x590x490	810x940x625	690 x 700 x 570
195 x 150	245 x 105	195 x 160	285 x 450	250 x 260	207 x 102	225 x 447
200 x 245	205 x 210	208 x 195	255 x 218	265 x 295	238 x 267	263 x 196
---	---	---	---	---	260 x 360	---
---	---	---	---	---	270x300x415	---
oben/rückwand top/back	oben/rückwand top/back	rückwand back	rückwand back	rückwand back	oben/rückw. top/back	oben/rückw. top/back
130	130	130	150	130	130	150
1,5 - 2,5	1,5 - 2,5	1,5 - 2,5	1,5 - 2,5	1,5 - 2,5	2 - 3	1,5 - 2,5
40	40	38	60	40	45	49
25/33	25/33	25/33	33/50	25/33	25/33	25/33
130	150	135	240	200	310	220
15	15	15	18	15	18	18
98	98	98	98	98	98	98
80	80	80	60	80	25	60
40	40	40	---	40	20	---
30	30	30	30	30	---	25
10	10	10	10	10	---	10
80	80	80	80	80	80	80
EN 13240	EN 13240	EN 13240	EN 13240	EN 13240	EN 12815	EN 13240

Die Ermittlung der Daten erfolgte im EN 13240-Versuch mit Kaminöfen mit waagrechttem Rauchrohranschluß, Rohrlänge 35 cm
The data was determined in an EN 13240 test with a chimney stove with a horizontal smoke tube connection, tube length 35 cm

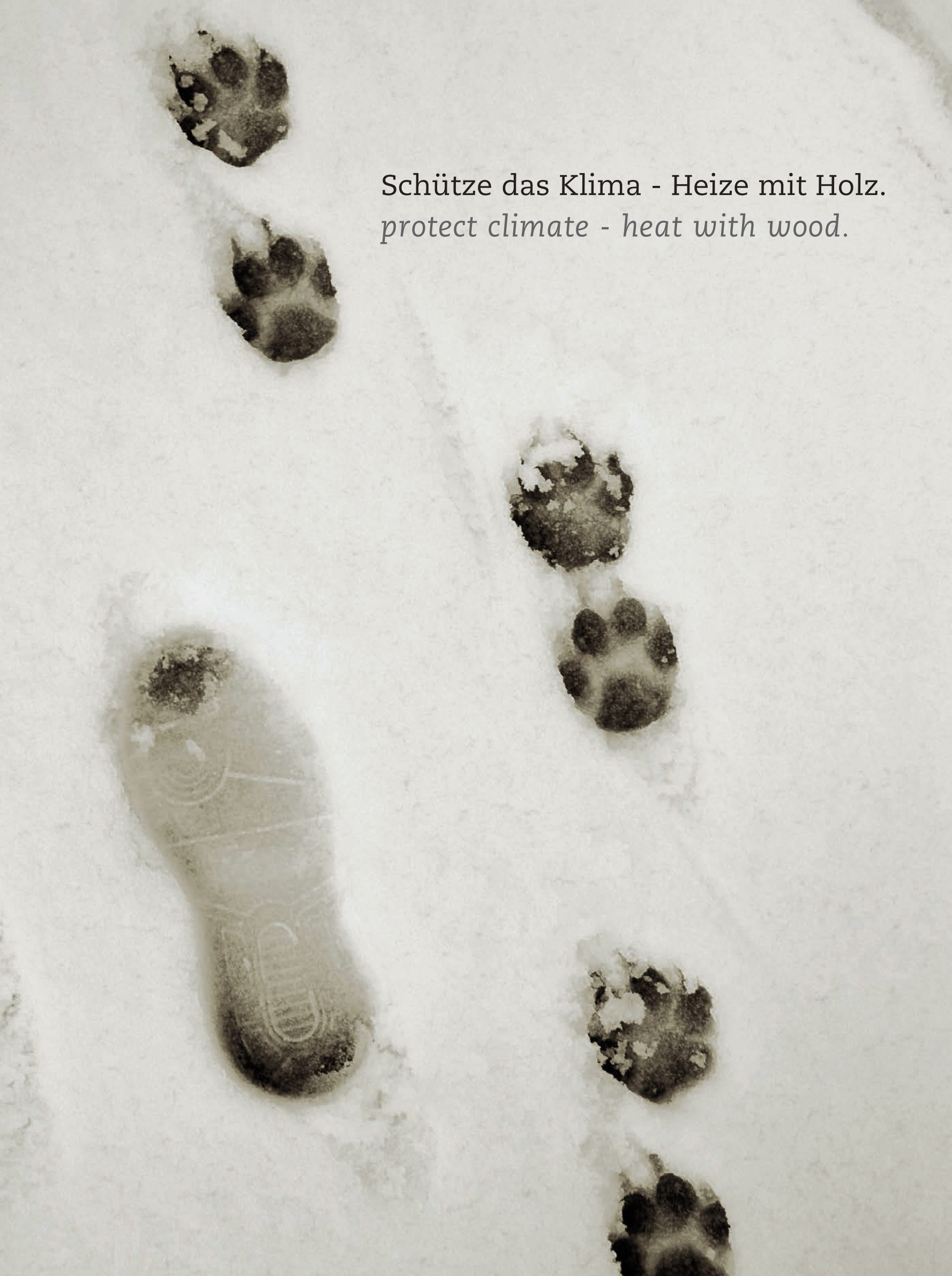
A close-up photograph of a snowy surface. On the left, a large, light-colored boot print is visible, showing some tread patterns. To its right, a series of dark, muddy paw prints are arranged in a path, leading from the top left towards the bottom right. The snow is bright white, and the paw prints are dark brown/black with some white snow mixed in.

Schütze das Klima - Heize mit Holz.
protect climate - heat with wood.

made in germany.

IRON DOG[®]

EISERNER HUND[®]

IRON DOG ist ein Produkt der Ulrich Brunner GmbH, Eggenfelden
IRON DOG is a product of Ulrich Brunner GmbH, Eggenfelden, Germany

IRON DOG ist eine geschützte Marke.
IRON DOG is a registered trademark.

Ulrich Brunner GmbH
Zellhuber Ring 17 - 18
D-84307 Eggenfelden
Germany
Telefon: +49 8721 771-0
Telefax: +49 8721 771-100
info@iron-dog.de www.iron-dog.de

IRON DOG wird ausschließlich vom qualifizierten Fachbetrieb angeboten und verkauft.
Technische und sortimentsbedingte Änderungen sowie Irrtümer vorbehalten. Sämtliche
Abbildungen können aufpreispflichtige Zusatzfunktionen bzw. Sonderausstattungen
enthalten. Nachdruck und Vervielfältigung, auch auszugsweise, nur mit ausdrücklicher
Genehmigung des Herausgebers.

IRON DOG is exclusively distributed by IRON DOG-Partners.
All products presented are subject to changes in technology, design and availability.
All images may contain additional functions or special equipment that are subject to
a surcharge. Reproduction and duplication, in whole or in part, only with the express
permission of the publisher.

